

# EXAMION®

X-Ray Systems · Digital Imaging · Service

## EXAMION X-ray systems

Individual solutions for individual needs





Your expert partner for X-ray systems.

## EXAMION GmbH

EXAMION is a specialist provider of digital radiography solutions dedicated to human and veterinary medicine, based in Germany. For more than 35 years now, we have been committed to the provision of future-oriented solutions in the areas of digital X-ray systems, software and support services with a focus on the requirements of resident physicians and medical care centers, large radiology departments and hospitals.

In addition to the classic X-ray systems, our product portfolio also includes mammography. In addition to controlling our X-ray systems, our innovative X-AQS software also incorporates image viewing and reporting facilities, as well as full archive storage for all medical imaging data.

EXAMION currently services approximately 10,000 systems. We constantly evaluate the needs of the individual market segments and align our business activities accordingly. We provide full support packages for our customers, from the planning and project management stages to expert installation and comprehensive technical support services.



### With the future in mind

When it comes to hardware, at EXAMION we attach particular importance to durability over time, with potential future developments always in mind. We aim to optimise and improve our products in collaboration with our customers. Our operating software is subject to continued updates.

### Innovation

Our innovative proprietary operating software can be flexibly adapted and is constantly being refined. This enables us to offer specialised solutions, such as mobile emergency applications.

### Customer-oriented

Our sales and service network is constantly expanding, so we can ensure that we are never too far away. This means we can be here for you throughout, during planning, installation and afterwards, and also if you need assistance with relocation, expansion or modifications in your medical practice or clinic.

### Quality awareness

As a medical technology specialist and provider with in-house hardware and software development, EXAMION offers a wide range of proven and tested solutions. We are proud that all of our products have been certified in-house by accredited institutions. This is a complex process that we consider more than worthwhile, because it is an assurance of high quality for our customers now and in the future.



### More than 35 years of experience and expertise in digital X-rays

EXAMION's successful business history began in 1989, and since then it has continued to consolidate its leading position as an innovator in its field. Our many years of experience make us a trusted partner for all your digital X-ray needs.



### With an eye on your budget

Our digital X-ray systems offer superior value for money. Choose the perfect system for your specific needs and applications with the best possible performance. We keep costs as low as possible for you.



## X-R X-ray systems

### Advantages of EXAMION X-ray systems

Optimized workflow and minimum time per X-ray exposure via:

- Reliable detector technology
- Controlled operation of all system components parts via the EXAMION X-AQS software
- Intuitive software design

Maximum image quality with:

- High-quality EXAMION detectors
- State-of-the-art image processing

### Applications

EXAMION offers proven X-ray solutions for practices and hospitals that can be optimally adapted to the type and number of patient examinations to be carried out. EXAMION also develops mobile and portable solutions for use in emergency situations.

Whether you are looking for a new device or want to replace an existing one: In collaboration with you, we will develop the perfect solution for your individual needs.

### Areas of application

		Resident physicians	Medical care centers	Radiology	Hospitals	Emergency containers
X-DRS Ceiling Standard			X	X	X	
X-DRS Ceiling Flow			X	X	X	
X-DRS Floor Basic		X	X			
X-DRS Floor Standard E		X	X	X	X	
X-DRS Floor U-Arm		X				
X-DRS Floor Z-Arm		X	X			
X-DRS Mobile Elite			X	X	X	X
X-DRS Mobile Pro 320			X	X	X	X
X-DRS Mobile 320			X	X	X	X

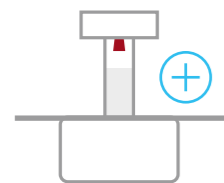

#### New purchase

You are about to invest in equipment for a new clinic or a new practice and are looking for a state-of-the-art X-ray system.

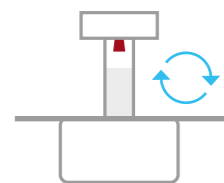

#### Exchange

Your current X-ray system is in need of repair. Instead of continuing to invest in the existing system, you are looking for a new system with the latest advanced operating features.



## Ceiling-mounted systems

A ceiling-mounted X-ray system satisfies all the demands of hospital settings, from standard X-ray examinations to operating room and casualty departments. The X-ray tube can be quickly and easily moved into a variety of positions so that you can take full advantage of the functions supported by the ceiling mount. This means that point of care and lateral X-ray images can also be acquired for recumbent patients.

In most cases, the systems are combined two detectors, one detector on the table, another on the wall unit. Systems for use with low patient throughput can also be equipped with just one detector. A maximum of four detectors can be connected, e.g. for tabletop or special exposures.

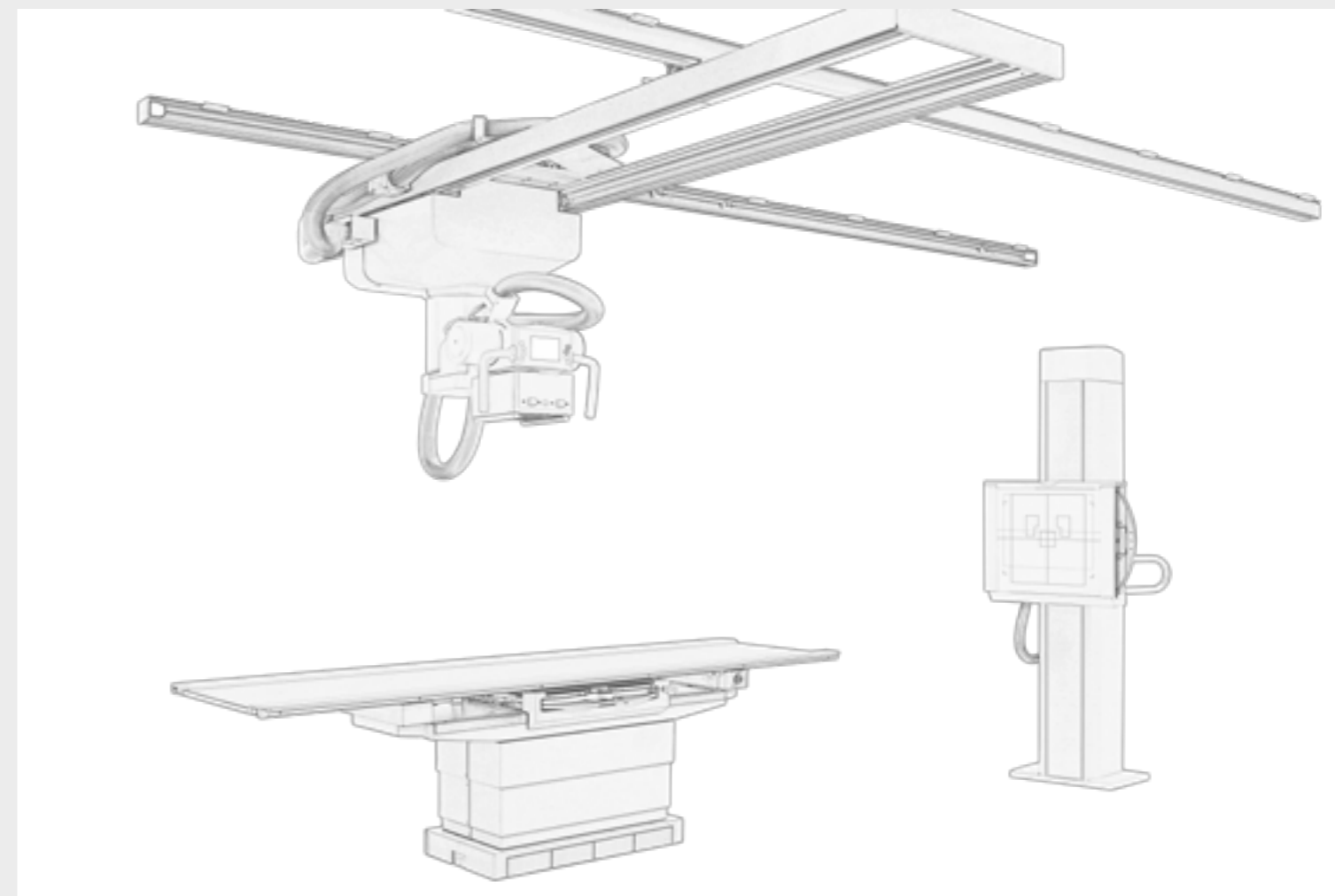



## X-DRS Ceiling Standard



Take a look on our website



### The all-in-one solution for the hospital setting

The X-DRS Ceiling Standard is an extremely sturdy X-ray system that is suitable for the entire range of radiological examinations in hospitals. The various X-ray tube and generator options are optimally tailored to the needs of hospitals and offer sufficient power reserves at all times. The various tracking functions guide the operator to correctly position the system prior to X-ray image acquisition.

The efficiency of the system also means low life-cycle costs. You can rely on consistent performance and benefit from minimal maintenance costs.

The standard system version is provided with tracking functions. The X-ray tube itself is motorised and is moved into position by the tracking system when the table or wall unit is moved. A purely mechanical version is available for special applications. The stitching function version offers the highest degree of motorised movement, allowing fully automatic full-leg or full-spine imaging acquisition at the wall unit.

The X-ray tube touchscreen means that parameters can be changed quickly and easily for an efficient work-flow.

#### Synchronisation

- Motorised tracking of the X-ray tube when changing the table height
- Motorised tracking of the X-ray tube when the bucky tray moves on the wall stand
- Stitching option: Bucky movement automatically results in correct positioning for the required partial images

### Technical specifications

Longitudinal range of the ceiling mount	3,500 mm (optional: 5,645 mm)
Transverse range of the ceiling mount (Y-axis)	2,150 mm (optional: 3,500 mm)
Vertical range of the X-ray tube (Z-axis)	1,800 mm
Tabletop dimensions (l x w)	240 cm x 80 cm
Tabletop height	54 cm to 93 cm ± 1.5 cm, motorized height adjustment
Tabletop movement range	Longitudinal: ±48 cm Transverse: ±14 cm
Tabletop load capacity	Max. 280 kg in recumbent position





## X-DRS Ceiling Flow



Coming soon!

### A reliable solution for everyone

Everyday hospital life constantly confronts you with growing challenges such as workload, staff turnover and cost pressure. The current possibilities of digital imaging offer you an effective answer to these challenges and at the same time take your patient care to a new level.

EXAMION develops X-ray systems for an efficient digital workflow to fully integrate with your hospital processes and accelerate the acquisition of X-ray images. With its smooth workflow and robust design, X-DRS Ceiling Flow can be a reliable solution that withstands the intensive hospital workload. At the same time, EXAMION systems guarantee you a high level of cost-effectiveness over their entire service life.

#### Precise Positioning

- Auto-positioning just by a single button; Automatic and fast alignment of the X-ray tube with the table and wall stand receptors according to pre-defined positions
- 4 different possibilities to activate auto-positioning movement
- Easy operation, high security and precision of all positioning movements

#### Fully-automatic Servo-motorized Movements

- Auto-tracking; Synchronized automatic movements in all axes between the X-ray tube and the table/wall stand receptors
- Capacitive handle
- Motorized height adjustment of the table and the wall stand bucky

### Technical specifications

Ceiling height at source image distance	2,700 mm to 3,000 mm
Focal spot vertical travel	2,000 mm
Overhead tube crane movement range	Longitudinal: 2,972 mm to 5,172 mm Transverse: 1,595 mm to 2,595 mm
Tilting wall stand vertical travel range	34 cm to 190 cm
Tabletop dimensions (l x w)	2,400 mm x 868 mm
Tabletop height	500 mm to 900 mm
Tabletop load capacity	350 kg





## Floor-mounted systems

---

EXAMION X-ray systems consisting of a bucky table and a wall stand are a tried and tested solution for small hospitals, as well as for medical care centres and resident physicians.

The systems are either combined with one movable detector or two detectors: one detector on the table, the second on the wall unit. A maximum of four detectors can be connected, to cover full on-the-table images or special image acquisition.

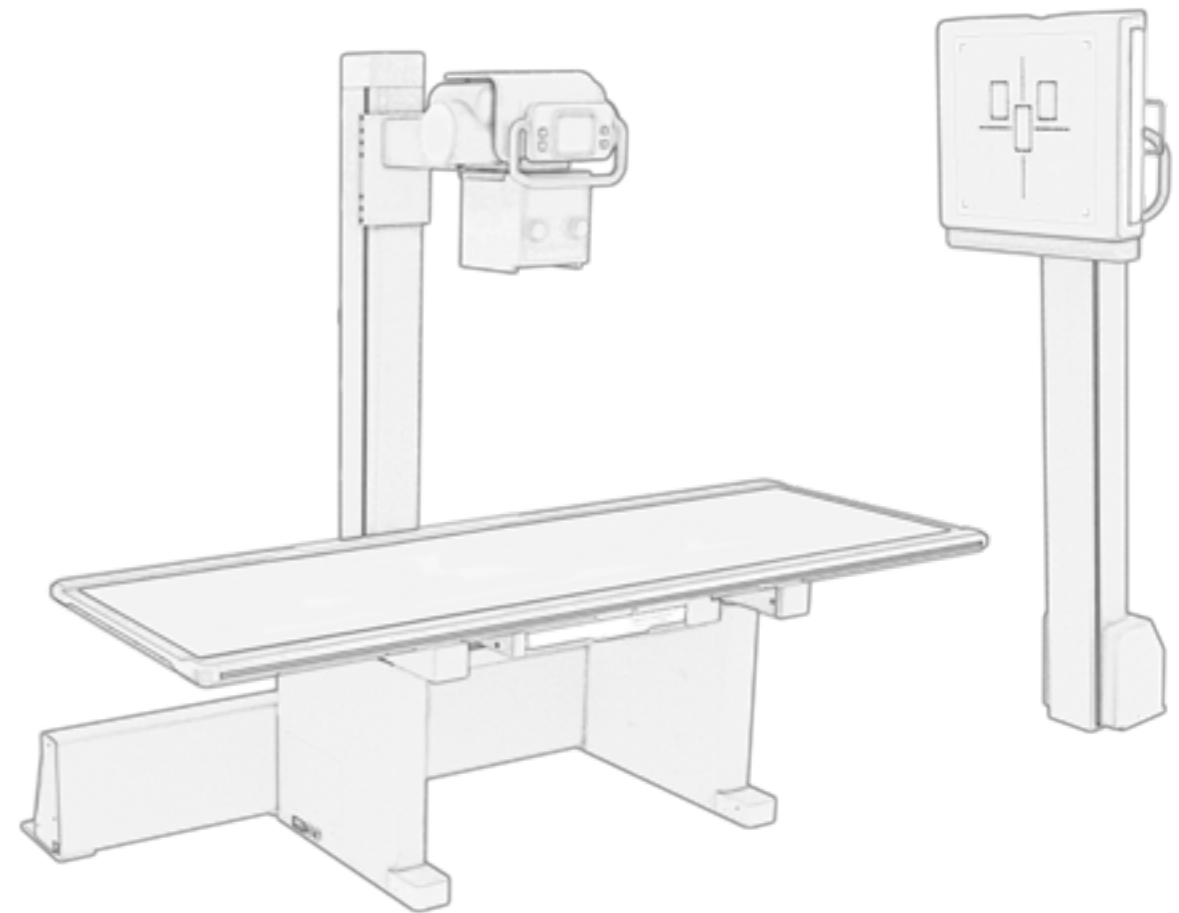



## X-DRS Floor Basic



Take a look on our website

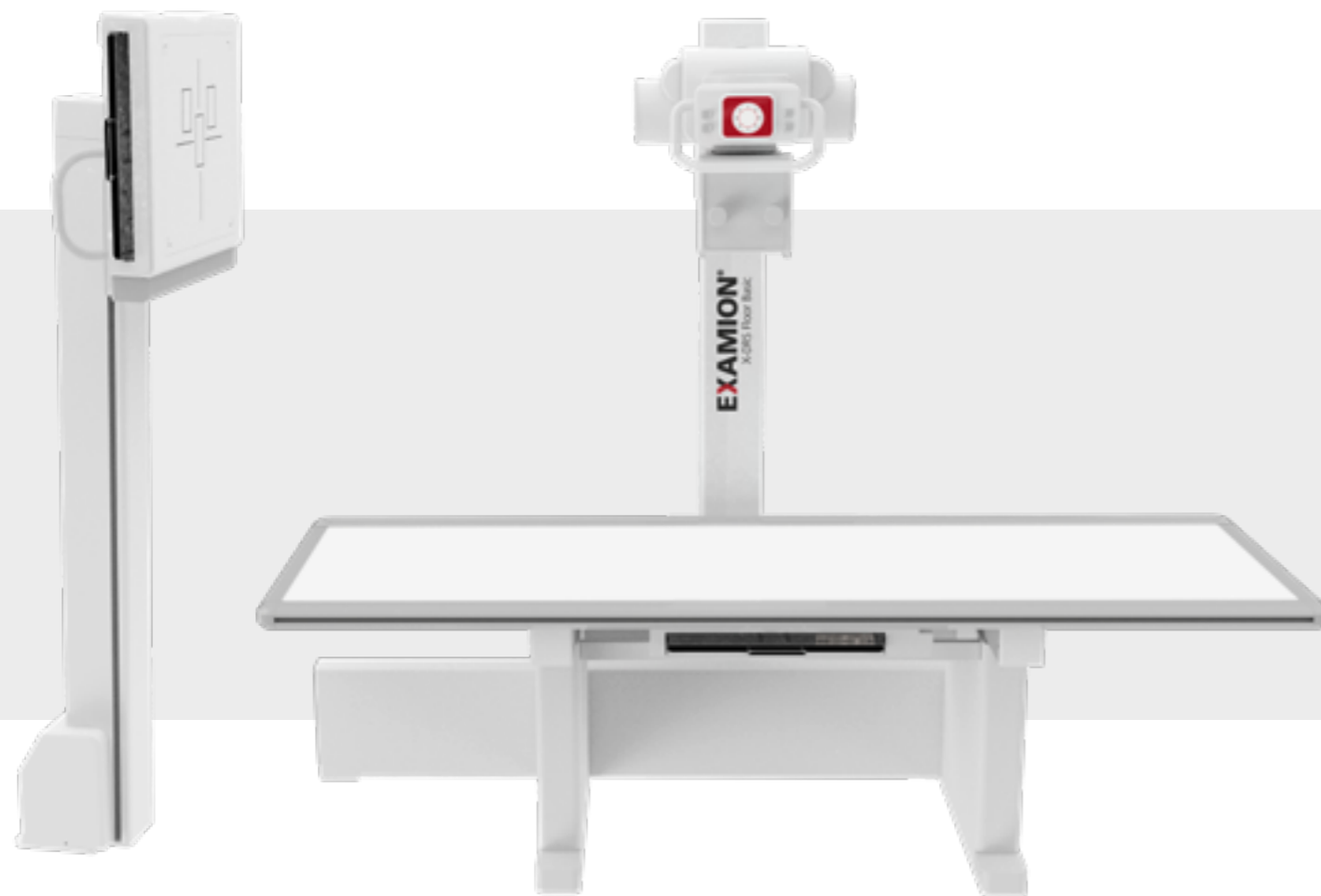

### Digital X-ray with superior value for money

The X-DRS Floor Basic from EXAMION is the perfect choice for resident physicians looking for the classic combination of a bucky table for recumbent position images and a wall unit for upright image acquisition.

With its compact size, the X-DRS Floor Basic takes up very little space. It is a robust and reliable device for X-ray examinations, ideally suited for regular everyday use.

The streamlined operating mechanism guarantees effortless positioning.

The electromagnetic brakes of the tabletop can be conveniently controlled by a foot-operated light barrier at the base of the X-ray table, for comfortable user-friendly operation.

#### Synchronisation

- Mechanism on the table to couple the X-ray tube and bucky tray for correct centring in all examinations, with the exception of angled exposures

### Technical specifications

Longitudinal range of the X-ray tube	136.5 cm
Vertical range of the X-ray tube	127.6 cm
Vertical range wall stand (centrally from X-ray base)	Minimum: 40 cm Maximum: 176.5 cm
Tabletop dimensions (l x w)	228 cm x 80.6 cm
Tabletop height	70 cm
Range tabletop	Longitudinal: ±50 cm Transverse: ±8.5 cm
Load tabletop	Max. 250 kg in recumbent position





## X-DRS Floor Standard E



Take a look on our website



### X-ray system consisting of a height-adjustable bucky table and a wall stand

The X-DRS Floor Standard E is particularly suitable for use in large medical practices, medical care centres or small hospitals. The height-adjustable table facilitates the examination, especially of patients with restricted mobility. The modular wall stand of this X-ray system is motorised. The user can choose whether to move the bucky manually or motorised. A motorised movement supports you especially in the fine adjustment of the bucky position. You can also upgrade the X-DRS Floor Standard E with the convenient stitching function in the future.

The X-DRS Floor Standard E is equipped with a height-adjustable table that reduces the operator's workload. Patients can comfortably assume their basic position at low table height and the user can comfortably perform the final positioning after raising the table top.

For increased ease of use and efficient operation, the bucky trays at the table and the wall unit are synchronised by electric motor with the X-ray tube, even for angled exposures. Operation is intuitive via the 10-inch touchscreen display.

#### Synchronisation

- Motorised tracking of the tabletop bucky tray, for correct centring of all images, including angle shot exposures
- Motorised tracking of the X-ray tube when changing the table height
- Motorised tracking of the X-ray tube emitter when the bucky tray moves on the wall stand

### Technical specifications

Longitudinal range of the X-ray tube	190 cm
Vertical range of the X-ray tube	149 cm
Vertical range wall stand (centrally from X-ray base)	Minimum: 40 cm Maximum: 189 cm
Tabletop dimensions (l × w)	228 cm × 80.6 cm
Tabletop height	53.2 cm – 83.2 cm, motorized height adjustment
Range tabletop	Longitudinal: ±38 cm Transverse: ±9.5 cm
Load tabletop	Max. 350 kg in prone position



## Swivel bracket

---

The EXAMION swivel bracket systems are among the most compact and space-saving X-ray systems and therefore ideal for small rooms and low ceilings.

The system is particularly easy to position for upright images, since the X-ray generator and bucky tray are coupled via the cross arm and can be synchronised at the desired height.

Thanks to the hinged swivel bracket cross arm, both recumbent and upright images can be taken using a single bucky tray. Intermediate positions of the cross arm for angle image exposures can also be programmed. The main advantage of systems with a single bucky tray is that the detector usually does not have to be removed and is therefore optimally protected. When other X-ray systems are combined with just one detector, it is placed alternately in the table and the wall unit. The swivel bracket is the ideal solution if you want to work with just one detector to optimize acquisition costs.

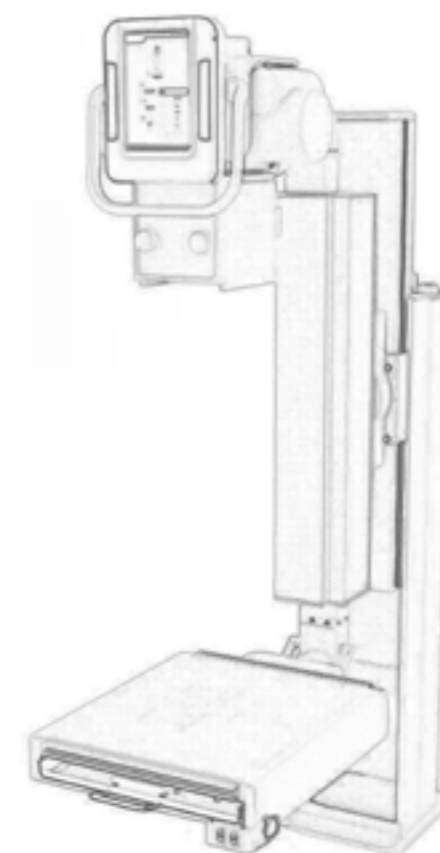



## X-DRS Floor U-Arm



Take a look on our website



### Space-saving X-ray system with motorized movement

The X-DRS Floor U-Arm Manual swivel bracket system is an ideal system for established practices that require a system that needs minimal space and place particular importance on ease of use and comfort. The system enables convenient operation via touchscreen as well as convenient positioning due to motorisation. This is the right device to avoid frequent removal of the detector from the bucky tray.

Thanks to motorised height adjustment of the cross arm and emitter/image distance, positioning requires little physical effort on the part of the operator. The adjustment is made with one click of a button. The system is thus able to relieve physical stress on operators who use the X-ray system uninterrupted and over prolonged periods of time.

A further simplification for the operating personnel is that various positions stored on the touchscreen can be accessed at the push of a button. The system also impresses with its modern design aesthetic.

#### Synchronisation

- X-ray emitter and bucky tray are directly linked for accurate centring

### Technical specifications

Vertical range transverse arm	40 – 170 cm, motorized
SID	100 – 180 cm
Rotation of the transverse arm	-30° to ≈120°
Wheel table	There are various models to choose from
Tabletop dimensions (l x w)	From 196.3 cm x 65.5 cm to 200 cm x 75.5 cm
Load tabletop	From max. 180 kg up to max. 230 kg

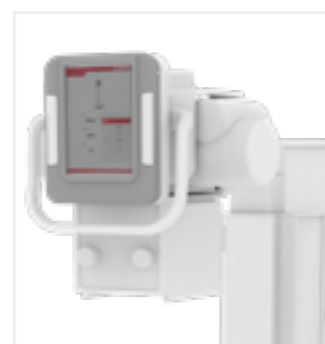



## X-DRS Floor Z-Arm



Take a look on our website



### Fully motorized X-ray system for all common applications

The X-DRS Floor Z-Arm swivel bracket is designed for ease of use in every respect. It is fully motorized – not a single movement needs to be performed mechanically. As a result, the X-DRS Floor Z-Arm also offers a comfortable stitching option.

The system particularly relieves physical stress on users who have to operate the X-ray system without interruption and over prolonged periods of time and who frequently have to acquire inclined images.

The system is conveniently positioned simply by pressing a button. Stored positions can be selected on the touchscreen; rotation of the bucky tray can be carried out as well via touchscreen. This means that positions for inclined images can be saved as well.

With optional stitching, not only the transverse arm is moved into different positions: the transverse arm as well as the detector are rotated in such a way that the individual beam cones all emanate from the same origin. This is the only way to achieve an optimal overlap of the individual images.

#### Synchronisation

- Automatic positioning of the system according to pre-programmed organ lists
- X-ray emitter and bucky tray are directly linked for accurate centring
- Stitching option: Automatic positioning for the required partial X-ray exposures

### Technical specifications

Vertical range transverse arm	40 – 170 cm, motorized
SID	100 – 180 cm
Rotation of the transverse arm	-30° to ≈120°
Wheel table	There are various models to choose from
Tabletop dimensions (l x w)	From 196.3 cm x 65.5 cm to 200 cm x 75.5 cm
Load tabletop	From max. 180 kg up to max. 230 kg





## Mobile systems

---

The mobile X-ray systems from EXAMION achieve an output of 32 kW per battery or socket and are therefore almost as powerful as a stationary system. Due to the performance of the systems the image quality also meets highest demands.

Our mobile systems are designed for maximum user support. Therefore, during development, great emphasis was put to smooth operation, stability and excellent user-friendliness





## X-DRS Mobile Elite



Take a look on our website



Coming soon!

### An optimal solution for everyone

Everyday hospital life constantly confronts you with growing challenges such as workload, staff turnover and cost pressure. The current possibilities of digital imaging offer you an effective answer to these challenges and at the same time take your patient care to a new level.

EXAMION develops X-ray systems for an efficient digital workflow. With the X-DRS Mobile Elite, you are able to control the entire imaging process directly from the patient's bedside. At the same time, EXAMION systems guarantee you a high level of cost-effectiveness over their entire service life.

#### Easy and precise positioning

- Effortless positioning in tight spaces
- Hand grips on the tube head and fine-tuning buttons on the tube handles

#### Easy operation

- Additional touch screen on the tube head
- Dual side collimator control panel on the front and back
- Safe storage options for detectors

#### Easy driving and maneuvering

- Motorized and smooth driving
- Compact and ergonomic
- Only one hand needed to move the whole unit
- Speed up to 5.5 km/h
- Stress-Free driving and a complete visibility ahead
- Small turning radius on the spot

### Technical specifications

Generator power (high frequency)	32 kW	40 kW	50 kW
Tube voltage	40 to 150 kVp in 1 kVp steps		
Tube power	10 to 500 mA	10 to 500 mA	10 to 500 mA (10 to 630 – Option)
Dimensions (l x w x h) in parking position	122 cm x 54 cm x 129 cm		
Focal point distance from floor	min. 53 cm, max. 202 cm (focus)		
Weight	520 kg		





## X-DRS Mobile Pro 320



Take a look on our website



### Mobile X-ray system ideal for bedridden patients

The X-DRS Mobile Pro 320 is a battery-powered mobile X-ray system with a detector that meets all the needs of hospitals. The integrated motorization makes it easy to overcome obstacles and inclines. The movement speed adapts to the user.

During transport the movement is controlled by the handle on the back. The precise motorized positioning on the patient is carried out using buttons on the X-ray tube.

With an optional telescopic stand – extended for use and retracted for transport – the mobile system is very flexible.

The X-DRS Mobile Pro 320 X-ray system has a power output of 32 kW and a monoblock generator with double focus X-ray tube. This permits highest quality X-ray image acquisition in the case of the extremities and the torso.

The standard model is combined with 35 cm x 43 cm detectors. Systems for neonatology use can also be equipped with 24 cm x 30 cm detectors by request.

The systems are equipped with MetaGrid image processing for acquisition of thorax images at the point of care. This means that scatter radiation is removed by the software, eliminating the need to use a grid.

### Technical specifications

Rated capacity	32 kW @100 kV, 320 mA, 100 ms
kV variation range	40 ÷ 125 kV in steps of 1 kV
mA variation range	70 ÷ 320 mA
mAs variation range	0.1 ÷ 320 mAs
Nominal focus dimensions	0.8 mm small focus, 1.3 mm large focus
Weight	397 kg including batteries

Telescopic arm option

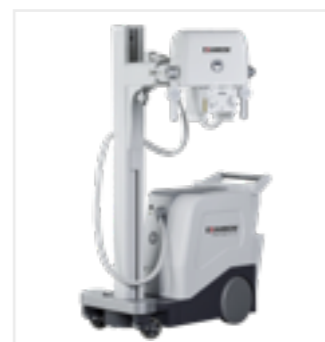



## X-DRS Mobile 320



Take a look on our website



### Mobile X-ray system ideal for emergency use

The X-DRS Mobile 320 is a manually mobile X-ray system with a detector. Its compact dimensions and smooth movement enable easy manoeuvring even in tight spaces.

Mobile X-ray systems are an indispensable tool for hospitals. Because the device can be moved, it can readily be used at the point of care. Transport of intensive care and trauma patients is unnecessary.

Our devices are robust and particularly easy to use so that you can concentrate fully on the patient, especially in emergency situations. The main focus is on support for ease of use by the operator.

#### Versions

- With rigid tube stand
- With a horizontally rotatable stand for easier positioning over the patient

### Technical specifications

Rated capacity	32 kW @100 kV, 320 mA, 100 ms
kV variation range	40 ÷ 125 kV in steps of 1 kV
mA variation range	50 ÷ 400 mA
mAs variation range	0.1 ÷ 220 mAs with increments of 12.5 %
Nominal focus dimensions	0.8 mm small focus, 1.3 mm large focus
Weight	170 kg







## Imaging plate systems

---

Imaging plate systems, also known as CR systems, represent ideal entry-level systems for digital image processing. They can be easily combined with virtually all existing X-ray systems.

In contrast to detector systems, also known as DR systems, which transmit the X-ray image directly to the computer control unit, the reading requires additional steps.





## X-CR Tabletop HighCap



Take a look on our website



### CR systems for digital X-ray

EXAMION imaging plate systems are a cost-optimised solution for digital X-rays. In contrast to detectors that transmit the X-ray image directly to the computer control unit, imaging plate systems require multiple steps. First, the imaging plate cassette is exposed by the X-ray system, then placed into the imaging plate scanner, and the imaging plate is automatically removed by the scanner and read.

Imaging plate systems are suitable if time pressure is moderate, if the lengthier time to acquire the X-ray image due to the more complex reading process being of lesser importance. In addition, imaging plate systems are based on proven technology. This is why the devices are also popular when fail-safe features play a major role, even under adverse environmental conditions.

The X-CR Tabletop HighCap can be easily combined with all existing X-ray systems, provided that the preferred 35 cm x 43 cm cassette format fits into the respective cassette tray.

The approximate throughput of the system is 50 cassettes in 35 cm x 43 cm format per hour. The time required to read the imaging plate cassettes is compensated to a certain extent by the fact that in addition to the 35 cm x 43 cm format, there are also smaller cassette formats available for which the reading process can be completed somewhat faster.

EXAMION's X-AQS software includes a special operating mode designed for image plate scanners. Clicking on 'Start' in the software program initiates the respective reading process. This software version offers the same performance as our standard version in terms of image post-processing and evaluation. It offers the full range of functions. If you subsequently decide to switch from an imaging plate system to a digital detector system, our software remains virtually the same. Very little extra training would be required.

Our X-CR Tabletop HighCap is a desktop device and is one of the most compact devices in its class.

### Technical specifications

Cassette formats	35 x 43 cm, 35 x 35 cm, 24 x 30 cm, 18 x 24 cm, 15 x 30 cm
Dimensions (w x h x d)	560 x 540 x 392 mm
Weight	39 kg
Grayscale resolution	12 bits
Pixel size	100 µm
Required reading time min.	49 sec
Time required for display start min.	33 sec





## Detectors

---

Our X-DR series detectors can be used to digitise stationary systems, as well as mobile and portable X-ray systems. Our customized retrofit solutions typically consist of a suitable flat-panel detector and our X-AQS software. Extensive modifications of your X-ray system are unnecessary.

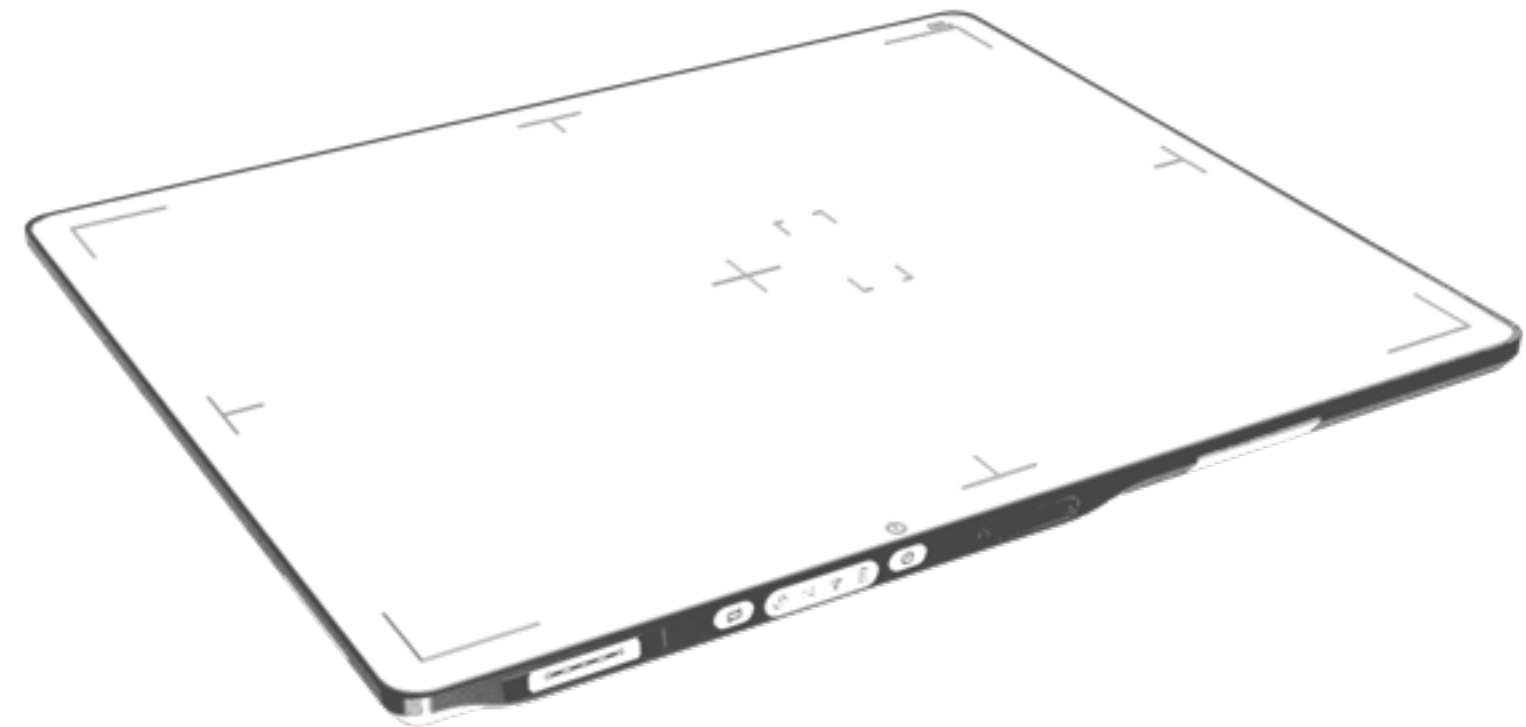



## X-DR WiFi – detectors in different sizes

Our detectors are the heart of the digital X-ray system. They ensure high-quality X-ray images while saving time and personnel costs.

The format of the detectors is similar to classical X-ray cassettes, so they can easily be retrofitted into existing systems. In addition, they are suitable for all the X-ray systems presented in this brochure.

Data can be transmitted via WiFi, and power can be supplied by battery. If the detector is permanently installed, the corresponding cabling for mains power supply is optionally available.



### Our most popular models at a glance

	X-DR L WiFi	X-DR L WiFi Premium	X-DR XL WiFi	X-DR XL WiFi Premium
Pixel pitch	150 µm	100 µm	139 µm	100 µm
Pixel matrix	2.304 × 2.800	3.500 × 4.300	3.072 × 3.072	4.267 × 4.267
Weight	3.4 kg	2.8 kg	4.6 kg	3.4 kg

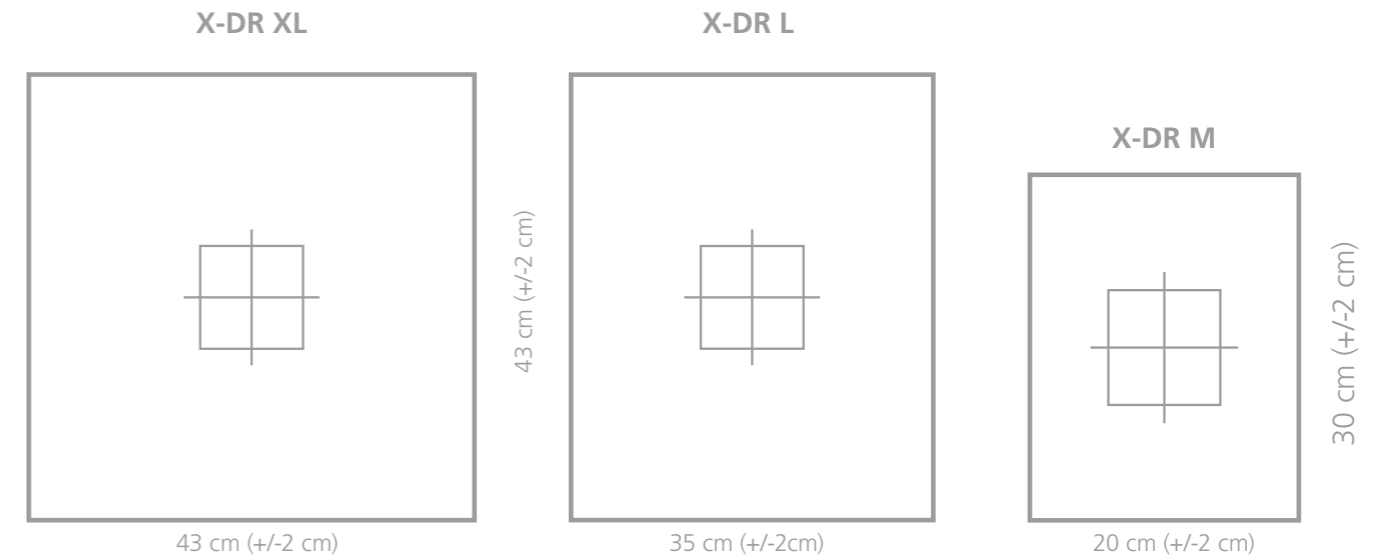

For stationary X-ray systems with two workstations – usually a bucky table and a wall-mounted unit – various options are available:

- A single detector can be used either in the bucky table or wall stand, as needed.
- In case of a two-detector solution, both the tabletop bucky tray and the wall-mounted device are equipped with their own detector. This avoids time-consuming swapping out of the detector between the tabletop and wall-mounted device.
- For extremity exposures and special positioning techniques, the tabletop bucky tray detector would be used. For a top of the range equipment version, however, there is also the option of coupling a third detector to the system for exposures of this type.

- EXAMION detectors are not just for stationary X-ray systems. There are numerous other options available:
- Detectors for mobile use at the point of care
- Portable case solutions for mobile use, e.g. in disaster areas.

### X-DR M WiFi

The small detector is the optimal addition, for example if a portable solution for acquisition of X-ray images of the extremities is needed. In addition, it is suitable for incubators in neonatology.

### X-DR L WiFi and X-DR XL WiFi

Our bestselling product offers superior value for money. One special feature of these detectors is their excellent image quality, which comply with the most demanding standards.

### X-DR L WiFi Premium and X-DR XL WiFi Premium

Our premium X-ray detectors are characterised by their lightweight design and high IP protection rating against ingress of fluids. Due to their small pixel size (only 100 µm), they offer digital X-ray images of outstanding quality able to satisfy even the highest radiological requirements.



## One Stop Shop & Service

---

With EXAMION as your partner for all concerns you benefit from a one-stop shop provider with long-standing experience. We provide comprehensive support for X-ray equipment, components, accessories and digital X-ray systems. Our comprehensive customer service will support you throughout the planning stages through to installation, and after.

Our expert technical staff and our extensive experience are the resource you need at your side. Thanks to our modular design principles you will always be able to find the right solution for your individual requirements.





## X-AQS Software – Acquisition, control, archiving

EXAMION X-AQS software provides a universal solution for X-ray image acquisition, processing and archiving, giving you control over a wide range of CR digitisers, DR detectors, X-ray generators and processes. The software is available in DICOM modality format, for connection to your existing image archive, and is also available as an X-AQS PACS system solution, with the same standard operation at viewer workstations



Take a look on our website

Our proprietary X-AQS software with its impressive user-friendly interface serves as the central control unit for digital X-rays. Simple and self-explanatory buttons enable the acquisition of perfect X-ray images with just a few clicks.

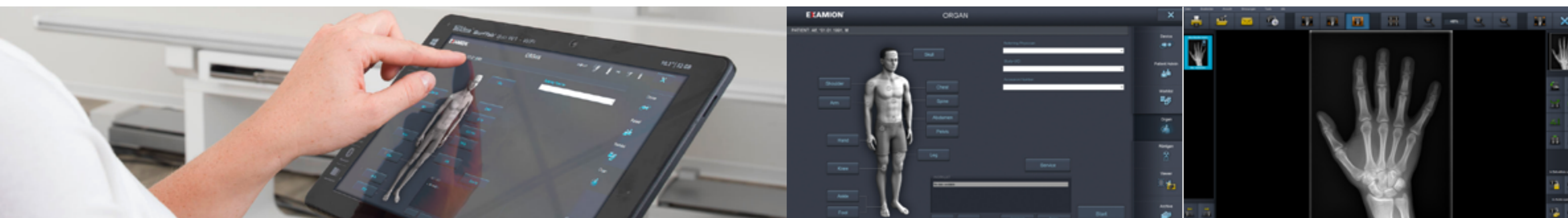

### Version 1

X-AQS with DICOM modality for connection to an existing image archive.

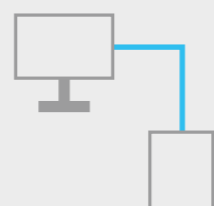

### Version 2

System solution with X-AQS PACS with integrated access even from viewer workstations.

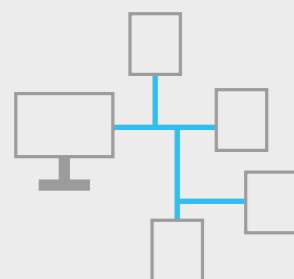

### Version 3

X-AQS hybrid model with local image mini-archive & additional storage in central archives.

### System instructions

Full touchscreen operation – easy selection of body region – freely configurable organ lists per body region

### Image acquisition

State-of-the-art X-AQS image processing – consistent operation with different image sources, even when switching between CR and DR systems – digital X-ray log

### Post-processing

Export to DICOM and other formats via USB stick, DVD and email – extensive image post-processing functions – measurement tools installed at acquisition workstations

### Additional functions with the X-AQS image archive

Client software for any number of viewer workstations – integration of peripheral devices such as ultrasound, endoscopy, CT and MRI

### Web client

Full-featured web client not only for image viewing but also, for example, for patient management and order placement



## -We are here for you for all your service needs

Our sales and service network is constantly expanding, so we can ensure that we are never too far away. This means we can be here for you throughout: during planning, installation and afterwards, with our full range of post-sales services. We also have you covered if you need assistance with relocation, expansion or modifications to your medical practice or clinic.



### Consultation

EXAMION complete X-ray systems meet even the highest demands. Our competently trained sales representatives will be happy to advise you at trade fairs or on-site.

In collaboration with you we will find the individual solution that perfectly supports your everyday work.

### Installation, maintenance, repair

With their extensive know-how, our technicians guarantee smooth commissioning of your new X-ray system during device installation.

But they are also available for maintenance and repairs in the long term.

### Hotline

For a smooth routine operation, our professional support can be contacted quickly and respond directly in case of questions – whether by telephone, via remote maintenance or by immediately assigning a field service technician.

### Short-term solutions

Until the repair can take place, we will help you quickly and easily. Therefore, you don't have to worry about prolonged downtimes, even in case of system defects.

We are committed to our customer's satisfaction. All of our departments work hand in hand to achieve this goal.



## Notes

---

---

---

---

---

---

---

---

---

---

---

---

---

---

---

---

---

---

---

---

---

---

---

---

---

---

---

---

---

---

---

---

---

---

---

---

---

---

---

---

---

---

---

---

---

---

---

---

---

---

---

---

---

---

---

---

---

---

---

---



# EXAMION GmbH

EXAMION is a global provider of specialized solutions for digital radiography in human and veterinary medicine. For more than 35 years now, we have been working based on the principle of "everything from a single source". We are available to our customers as a competent partner for planning, installation, and after-sales services.



Our technical and sales advice is tailored to the specific requirements of the customers and the practice premises. Contact our experts for your personalized advice!

EXAMION currently services over 7,000 systems, most of which are stationary X-ray systems installed in medical and veterinary hospitals and practices. Our in-house developed EXAMION X-AQS software empowers the system control, image processing, reporting, and archiving while ensuring efficient workflow. In addition to digital radiography and image processing systems, our product portfolio includes digital mammography.

With more than 150 employees in Germany, our European subsidiaries in Belgium, Poland, Portugal, and Switzerland, and our ever-growing network of service and sales partners, we passionately support our customers throughout Europe and beyond.

## Take advantage of our long-standing experience



X-ray systems

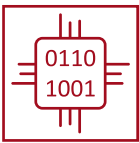

Digital systems

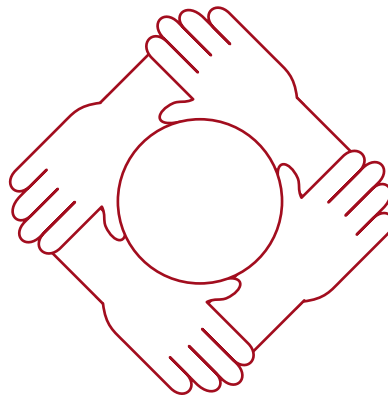

Image archives



Services



## Contact – your local sales and service partners

### EXAMION GmbH

Erich-Herion-Straße 37  
70736 Fellbach  
Germany

Phone: +49 711 120 002-0  
Fax: +49 711 120 002-22  
E-mail: [vertrieb@examion.com](mailto:vertrieb@examion.com)  
Web: [examion.com](http://examion.com)



Certified partner of EXAMION